

AGAVE WIRE, LTD

Toll-Free (800) 690-3408

An ISO 9001 Certified Quality Management System

Fax: (469) 547-4242

PRODUCT DATA SHEET

PRODUCT OVERVIEW:

APU-1801

CONSTRUCTION:	18 AWG Solid Copper w/ PE45 Jacket
APPROVALS:	UL Misc. Wires
APPLICATION:	Golf Course/Lawn Sprinkler Systems and Tracer Wire

CONSTRUCTION PARAMETERS:

CONDUCTOR:	18 AWG Solid Annealed Bare Copper
STRANDING:	Solid
NUMBER OF CONDUCTORS:	1
INSULATION MATERIAL:	PE
INSULATION THICKNESS:	0.045" Nominal
COPPER O.D.:	0.04"
FINISHED O.D.:	0.132" Nominal
WEIGHT PER 1000ft:	9.86 LBS

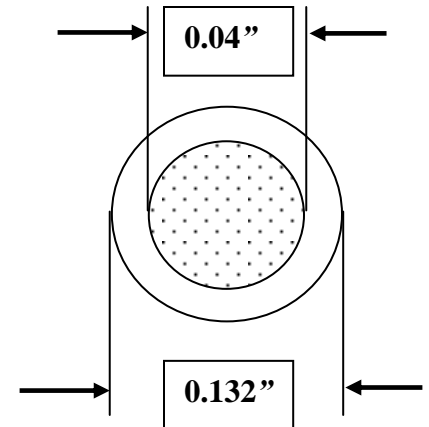

ELECTRICAL & ENVIRONMENTAL PROPERTIES:

TEMPERATURE RATING:	-20° c to 60° c
OPERATING VOLTAGE:	600v
INSULATION COLOR:	Various Colors Available

PRINT LEGEND:

Printing options available - call Agave for exact print line

On special orders, the customer will accept all mil lengths and +/- 10% of total order requested. The information presented here is, to the best of our knowledge, is true and accurate. However, since conditions of use are beyond our control, all recommendations or suggestions are presented without guarantee or responsibility on our part. We disclaim all liability in connection with the use of information contained herein or otherwise.

This specification is proprietary intellectual property of Agave Wire. Any information contained herein shall not be disclosed to any party without written consent of Agave Wire.

Manufactured in the U.S.A.